

Electromagnetic flowmeters

- Primary heads
- Compact flowmeters

ECOFLUX
IFS 1000 F

IFM 1010 K
IFM 1080 K



IFS 1000 F

CONTENTS

Installation in the pipeline

Pages 4-5 and 7-8

Grounding

Pages 8-9



IFM 1010 K



IFM 1080 K

Contents

System description	2
Product liability and warranty	2
Standards and approvals	2
Items included with supply	3
1 Important information for installation: PLEASE NOTE	4-5
2 Suggestions for installation	5
3 Instrument nameplate	6
4 Flowmeter versions	6
5 Installation in the pipeline	7
6 Torques	8
7 Grounding	8-9
8 Replacement of separate primary head IFS 1000 F	10
9 Spares and order numbers	10
10 Technical data	11
11 Dimensions and weights	12-13
Notes	14
Printed form to accompany flowmeters returned to Krohne	15

System description

ECOFLUX electromagnetic flowmeters are precision measuring instruments designed for the linear flow measurement of process liquids.

The process liquids must be electrically conductive: $\geq 5 \mu\text{S/cm}$
 $\geq 20 \mu\text{S/cm}$ for demineralized cold water

The **full-scale range** $Q_{100\%}$ can be set as a function of the **meter size**:

DN 10 - 150 / $\frac{3}{8}$ " - 6" $Q_{100\%} = 0.1 - 760 \text{ m}^3/\text{hr} = 0.4 - 3350 \text{ US Gal/min}$
This is equivalent to a flow velocity of 0.3 - 12 m/s, or 1 - 40 ft/s.

Product liability and warranty

ECOFLUX electromagnetic flowmeters are designed solely for measuring the volumetric flowrate of electrically conductive, liquid process products.

Flowmeters with the ECOFLUX primary head are not certified for use in hazardous locations. Other flowmeter series are available for such applications.

Responsibility as to suitability and intended use of these electromagnetic flowmeters rests solely with the operator.

Improper installation and operation of the flowmeters (systems) may lead to loss of warranty.

In addition, the "General conditions of sale" forming the basis of the purchase contract are applicable.

If ECOFLUX flowmeters need to be returned to Krohne, please note the information given on the last-but-one page of this manual. Krohne regret that they cannot repair or check your flowmeter(s) unless accompanied by the completed form sheet.

Standards and approvals

Please refer to the installation and operating instructions for the signal converter.

Items included with supply

**IFS 1000 F
primary head**

- primary head in the size as ordered
- certificate of calibration data
- installation material as specified in the following table
- installation instructions

**IFM 1010 K and IFM 1080 K
compact flowmeters**

- compact flowmeter in the size as ordered
- certificate of calibration data
- installation material as specified in the following table
- installation instructions
- installation and operating instructions for the signal converter

Nominal size measuring tube and pipe flanges	Pressure rating or flange class of pipe flanges	Max. allowable operating pressure		Supply scope S=standard O=option		
				excl. grounding rings	incl. grounding rings	Standard with centering sleeves (optionally with stud bolts, see below for type and number
		bar	psig	2)	3)	
... DIN 2501 (BS 4504)						
DN 10-15 1)	PN 16/PN 40	≤ 16	≤ 230	–	S	4 × M12
DN 25	PN 16/PN 40	≤ 16	≤ 230	S	O	4 × M12
DN 40	PN 16/PN 40	≤ 16	≤ 230	S	O	4 × M16
DN 50	PN 16/PN 40	≤ 16	≤ 230	S	O	4 × M16
DN 80	PN 16/PN 40	≤ 16	≤ 230	S	O	4 × M16
DN 100	PN 16 PN 40	≤ 16	≤ 230	S	O	8 × M16 8 × M20
DN 150	PN 16 PN 40	≤ 16	≤ 230	S	O	8 × M20 8 × M24
... ANSI B 16.5						
3/8"-1/2" 1)	150/300 lb	≤ 16	≤ 230	–	S	4 × 1/2"
1"	150/300 lb	≤ 16	≤ 230	S	O	4 × 1/2"
1 1/2"	150/300 lb	≤ 16	≤ 230	S	O	4 × 5/8"
2"	150 lb 300 lb	≤ 16	≤ 230	S	O	4 × 5/8" 8 × 5/8"
3"	150 lb 300 lb	≤ 16	≤ 230	S	O	4 × 5/8" 8 × 5/8"
4"	150/300 lb	≤ 16	≤ 230	S	O	8 × 5/8"
6"	150 lb 300 lb	≤ 16	≤ 230	S	O	8 × 3/4" 12 × 3/4"
... JIS						
DN 10-15 1)	10 K 20 K	≤ 07 ≤ 14	≤ 100 ≤ 200	–	S	4 × M12 4 × M12
DN 25	10 K 20 K	≤ 07 ≤ 14	≤ 100 ≤ 200	S	O	4 × M12 4 × M16
DN 40	10 K 20 K	≤ 07 ≤ 14	≤ 100 ≤ 200	S	O	4 × M12 4 × M16
DN 50	10 K 20 K	≤ 07 ≤ 14	≤ 100 ≤ 200	S	O	4 × M12 8 × M16
DN 80	10 K 20 K	≤ 07 ≤ 14	≤ 100 ≤ 200	S	O	8 × M12 8 × M20
DN 100	10 K 20 K	≤ 07 ≤ 14	≤ 100 ≤ 200	S	O	8 × M12 8 × M22
DN 150	10 K 20 K	≤ 07 ≤ 14	≤ 100 ≤ 200	S	O	8 × M16 12 × M22

- 1) For DN 10 and 3/8" sizes, use DN 15 or 1/2" pipe flanges.
- 2) Ground connecting wires V screwed to housing, supplied without gaskets.
- 3) **DN 10 - 15 and 3/8" - 1/2"**: grounding rings E with inserted D1 gasket, screwed to housing.
D2 gaskets between grounding rings and pipe flanges not included with flowmeter, to be provided by customer.
Use Teflon-type gaskets to DIN 2690/ANSI B 16.21, deformable under pressure, 8 - 16 N/mm²/1160 - 2320 psi.
DN 25 - 150 and 1" - 6": grounding ring E (option) supplied loose, ground connecting wires V screwed to housing, gaskets not included in supply.

For arrangement of gaskets and connection of wires V, see Section 7 "Grounding".

1 Important information for installation: PLEASE NOTE

- Handling**

Do not lift flowmeter by the signal converter housing or the terminal box.

Do not set flowmeter down on signal converter housing or terminal box.

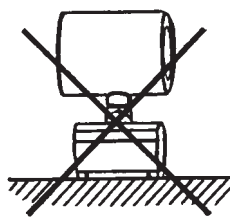
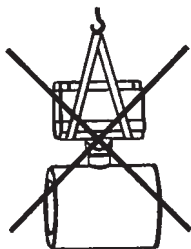

- Use only solventless detergents to **clean** the signal converter housing (polycarbonate).

- Temperatures**

For operating pressure and vacuum load based on flange standards, see Section 10 "Technical data".

	Ambient temperature	Process temperature
Compact systems	-25 to +50 °C (-13 to +122 °F)	-25 to + 60 °C (-13 to +140 °F)
	-25 to +40 °C (-13 to +104 °F)	-25 to +120 °C (-13 to +248 °F)
IFS 1000 F (separate)	-25 to +60 °C (-13 to +140 °F)	-25 to +120 °C (-13 to +248 °F)
In storage	-25 to +60 °C (-13 to +140 °F)	–

- Location and position as required,** but electrode axis **X – • – • – • – X** must be approximately horizontal in a horizontal pipe run.

Y terminal box or converter housing

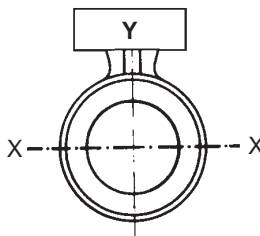

- Measuring tube must be completely filled at all times.**
- Direction of flow is arbitrary.** Arrow on flowmeter can normally be ignored. For exceptions, refer to Section "Factory settings" in the installation and operating instructions for the signal converter.
- Stud bolts and nuts:** to fit, make sure there is sufficient room next to the pipe flanges.
- Vibration:** support the pipeline on both sides of the compact flowmeter. Level of vibration in conformity with IEC 068-2-34: below 2.2g for compact flowmeters in the frequency range of 20-50 Hz with the IFC 010 K and 20-150 Hz with the IFC 090 K.
- Do not expose to direct sunlight,** fit a sunshade if necessary, not included with flowmeter, to be provided by customer.

- **Strong electromagnetic fields**, avoid in vicinity of flowmeter.
- **Straight inlet run minimum of $5 \times \text{DN}$ and outlet run minimum of $2 \times \text{DN}$** , (DN = meter size), measured from the electrode axis.
- **Vortex and corkscrew flow**: increase length of inlet and outlet runs or install flow conditioners.
- **Mixing different process liquids**: install flowmeter upstream of mixing point or at an adequate distance downstream (minimum of $30 \times \text{DN}$), otherwise display may be unsteady.
- **Plastic pipes and internally coated metal pipelines**: grounding rings required, see Section 7 "Grounding".
- **Insulated pipeline**: do not insulate flowmeter.
- **Zero setting not necessary**. To check, it should be possible to set "zero" flow velocity in the completely filled measuring tube. Shutoff valves should therefore be provided either downstream of the flowmeter or upstream and downstream of the flowmeter.

2 Suggestions for installation

To avoid measuring errors due to gas/air inclusion or to pipe running empty please observe the following:

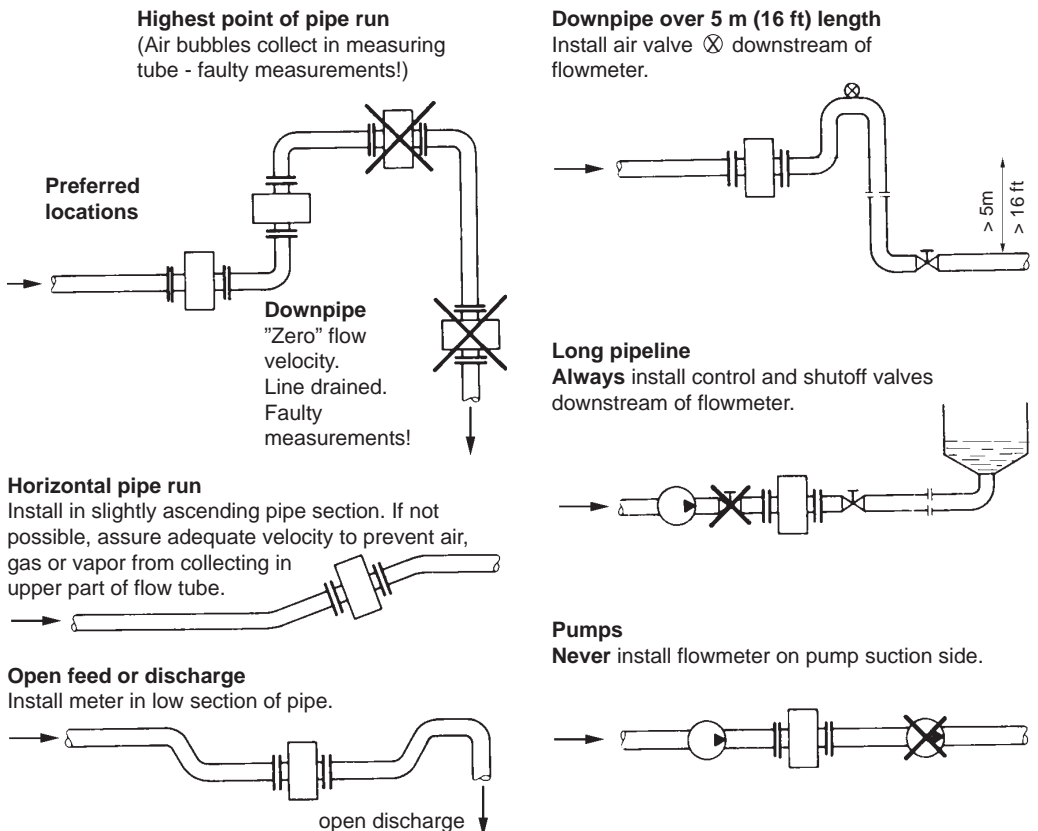

3 Instrument nameplate

IFS 1000 F

separate primary head

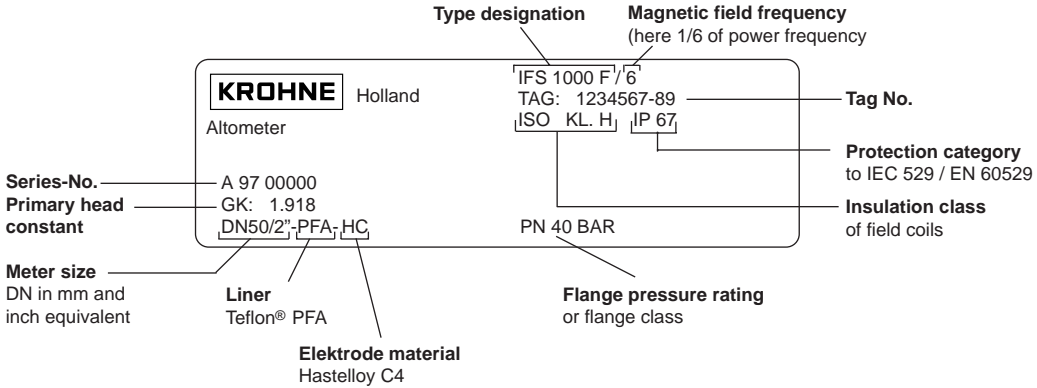

Teflon® is a registered trademark of Du Pont

Instrument nameplate for compact flowmeters

see installation and operating instructions for the signal converter.

4 Flowmeter versions

IFS 1000 F **Separate primary head (F)**, electrically connected to the signal converter by signal and field current cables.

IFM 1010 K **Compact flowmeter (K)**, IFC 010 K signal converter mounted direct on the primary head.

IFM 1080 K **Compact flowmeter (K)**, IFC 090 K signal converter mounted direct on the primary head.

5 Installation in the pipeline

- **Installation material**, refer to table on page 3.
- **Pipe flanges and operating pressure**, refer to table on page 3.
- **Pipe flange spacing** (fitting dimension)

Nominal size to . . .		Space between pipe flanges	
DIN 2501 and JIS	ANSI B 16.5	Installation with grounding rings 1)	Installation without grounding rings 2)
DN 10, 15	$\frac{3}{8}$ ", $\frac{1}{2}$ "	2 x s + 68 mm (2 x s + 2.68")	– –
DN 25	1	2 x s + 60 mm (2 x s + 2.38")	54 mm (2.13")
DN 40	$1 \frac{1}{2}$ "	2 x s + 84 mm (2 x s + 3.31")	78 mm (3.07")
DN 50	2	2 x s + 106 mm (2 x s + 4.17")	100 mm (3.94")
DN 80	3	2 x s + 156 mm (2 x s + 6.14")	150 mm (5.91")
DN 100	4	2 x s + 206 mm (2 x s + 8.11")	200 mm (7.87")
DN 150	6	2 x s + 206 mm (2 x s + 8.11")	200 mm (7.87")

- 1) Dimensions including grounding rings
 - 2) No gasket required between measuring tube and pipe flanges, seal provided by PFA liner on the flanges
- s Thickness of gasket D2 between grounding rings and pipe flanges, not included with flowmeter, to be provided by customer. Use Teflon-type gaskets, deformable under pressure, to DIN 2690/ANSI B 16.21, 8 - 16 N/mm²/1160 - 2320 psi.

- **High-temperature pipelines**

Where process temperatures exceed 100 °C/212 °F, provide for facilities to compensate for longitudinal expansion on heat-up of the pipeline.

For **short** pipelines use resilient gaskets and for **long** pipelines install flexible pipe elements (e.g. elbows).

- **Position of flanges**

Install flowmeter in line with the pipe axis. Pipe flange faces must be parallel to each other, max. permissible deviation:

$$L_{\max} - L_{\min} \leq 0,5 \text{ mm} \\ \leq 0.02''$$

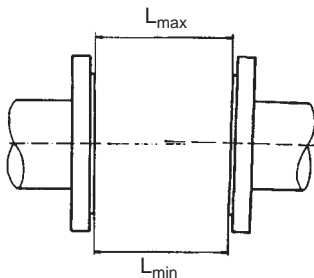

- **Arrangement of centering sleeves**

- 1 washer
- 2 centering sleeve
- 3 stud bolt
- 4 hex. nut

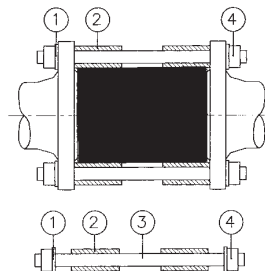

6 Torques

Nominal size measuring tube and pipe flanges	Pressure rating or flange class of pipe flanges	Max. allowable operating pressure		Max. torques stud bolts	
		bar	psig	Nm	ft x lbf
... DIN 2501 (BS 4504)					
DN 10-25 1)	PN 16/PN 40	≤ 16	≤ 230	16	11.6
DN 40	PN 16/PN 40	≤ 16	≤ 230	25	18.1
DN 50	PN 16/PN 40	≤ 16	≤ 230	45	32.5
DN 80	PN 16/PN 40	≤ 16	≤ 230	25	18.1
DN 100	PN 16/PN 40	≤ 16	≤ 230	33	23.9
DN 150	PN 16/PN 40	≤ 16	≤ 230	82	59.3
... ANSI B 16.5					
³ / ₈ "-1 ¹ / ₂ " 1)	150/300 lb	≤ 16	≤ 230	16	11.6
1"	150/300 lb	≤ 16	≤ 230	15	10.8
1 1 ¹ / ₂ "	150/300 lb	≤ 16	≤ 230	25	18.1
2"	150/300 lb	≤ 16	≤ 230	45	32.5
3"	150 lb 300 lb	≤ 16	≤ 230	56 28	40.5 20.5
4"	150/300 lb	≤ 16	≤ 230	36	26.0
6"	150 lb 300 lb	≤ 16	≤ 230	100 66	72.3 47.7
... JIS					
DN 10-15 1)	10 K 20 K	≤ 7 ≤ 14	≤ 100 ≤ 200	16 16	11.6 11.6
DN 25	10 K 20 K	≤ 7 ≤ 14	≤ 100 ≤ 200	16 19	11.6 13.7
DN 40	10 K 20 K	≤ 7 ≤ 14	≤ 100 ≤ 200	20 17	14.5 12.3
DN 50	10 K 20 K	≤ 7 ≤ 14	≤ 100 ≤ 200	35 24	25.3 17.4
DN 80	10 K 20 K	≤ 7 ≤ 14	≤ 100 ≤ 200	20 30	14.5 21.7
DN 100	10 K 20 K	≤ 7 ≤ 14	≤ 100 ≤ 200	26 89	18.8 28.9
DN 150	10 K 20 K	≤ 7 ≤ 14	≤ 100 ≤ 200	65 89	47.0 64.3

1) For meter sizes DN 10 and ³/₈", use pipe flanges DN 15 or 1¹/₂".

7. Grounding

- **Warning:** All flowmeters must be properly grounded to avoid personnel shock hazard.
- The ground conductor should not transmit any interference voltages, therefore do not ground any other electrical devices together with this conductor.

Separate primary head IFS 1000 F with terminal box

- A functional ground FE must always be connected.
- **Signal converters with a field power supply of > 125 mA / > 60 V** for the primary heads should not be operated with the IFS 1000 F.

Compact systems

Supply power > 50 V AC

- Grounding is via the **PE protective ground conductor** incorporated in the power supply cable, see also Section "Connection to power" in the installation and operating instructions for the signal converter.
- **EXCEPTION: Do not connect up the PE protective ground conductor in the terminal box** if e.g. compact units are operated in the proximity of electric furnaces, electrolysis plants, etc., and large potential differences occur in the pipeline system. An FE functional ground must simultaneously take over the function of the protective conductor (combined protective/functional ground). Refer to appropriate national codes for specific requirements for this type of installation, which may require the addition of a ground fault detection circuit interrupter.

Power supply 24 V AC or DC

- Protective separation (PELV) must be ensured (VDE 0100/VDE 0106 or IEC 364/IEC 536 or equivalent national regulations).
- An **FE functional ground conductor** must be connected for measurement reasons.

Grounding diagrams

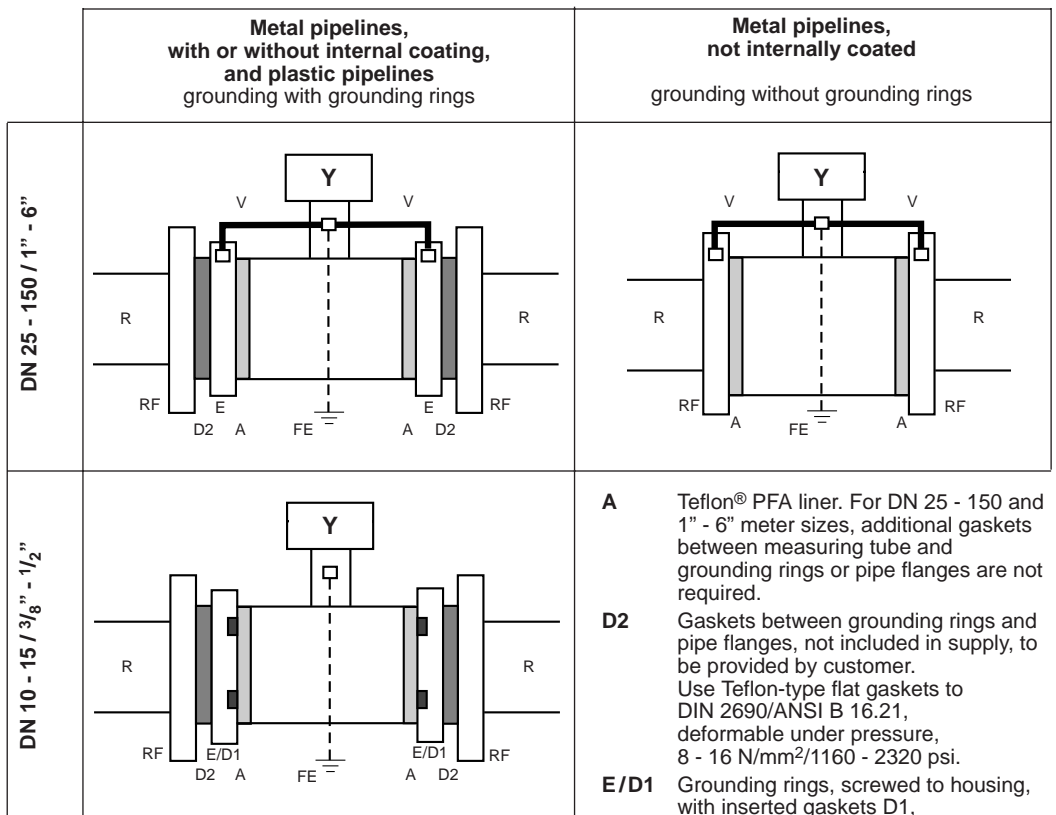

- A** Teflon® PFA liner. For DN 25 - 150 and 1" - 6" meter sizes, additional gaskets between measuring tube and grounding rings or pipe flanges are not required.
- D2** Gaskets between grounding rings and pipe flanges, not included in supply, to be provided by customer. Use Teflon-type flat gaskets to DIN 2690/ANSI B 16.21, deformable under pressure, 8 - 16 N/mm²/1160 - 2320 psi.
- E/D1** Grounding rings, screwed to housing, with inserted gaskets D1, special O-rings.
- FE** Functional ground, conductor ≥ 4 mm² Cu/AWG 10.
- R** Pipeline
- RF** Pipe flanges
- V** Interconnecting wires, bolted to housing.
- Y** Terminal box or signal converter.

8 Replacement of the separate primary head IFS 1000 F

Switch off power source before commencing work!

- 1) Note down terminal assignment before dismantling the "old" primary head.
- 2) Install the new primary head as described in the supplied installation instructions.
- 3) Make electrical connection at the signal converter as described in the installation and operating instructions for the signal converter.
- 4) Specific calibration data are defined during factory calibration for each primary head, which are indicated on the instrument nameplate.
This includes the primary constant GK and the magnetic field frequency. These data need to be reset in the signal converter.
- 5) If the size of primary head is also different from the old one, the full-scale range $Q_{100\%}$ and the meter size will need to be reset.
- 6) After resetting the signal converter, carry out a zero point check.
- 7) If necessary, reset the internal electronic totalizer of the signal converter.

9 Spare parts and order numbers

O-ring gasket D1 for the grounding rings

DN 10, 15 $\frac{3}{8}$ ", $\frac{1}{2}$ " **Order No.** 53002602

Grounding rings E

DN 25	1"	Order No.	231157-01
DN 40	$1\frac{1}{2}$ "		230505-11
DN 50	2"		231157-03
DN 80	3"		231157-04
DN 100	4"		231157-05
DN 150	6"		231157-06

10. Technical data

Meter sizes	DN 10 - 150 and 3/8" - 6"	
Pipe flanges to DIN 2501 (=BS 4504) to ANSI B 16.5 to JIS	DN 10 - 150 / PN 16 or PN 40 3/8" - 6" / Class 150 and 300 lb / RF DN 10 - 150 / 10 K and 20 K	
Electrical conductivity	≥ 5 μS/cm, ≥ 20 μS/cm for demineralized cold water	
Temperatures Compact systems	<u>Ambient temperature</u> -25 to +50 °C/-13 to +122 °F -25 to +40 °C/-13 to +104 °F	<u>Process temperature</u> -25 to + 60 °C/-13 to +140 °F -25 to +120 °C/-13 to +248 °F
IFS 1000 F (separate)	-25 to +60 °C/-13 to +140 °F	-25 to +120°C/-13 to +248 °F
In storage	-25 to +60 °C/-13 to +140 °F	–
Operating pressure with pipe flanges to ... DIN 2501 (=BS 4504) ... ANSI B 16.5 ... JIS 10 K 20 K	≤ 16 bar/≤ 230 psig ≤ 16 bar/≤ 230 psig ≤ 10 bar/≤ 150 psig ≤ 16 bar/≤ 230 psig	
Vacuum load	0 mbar abs./0 psia, fully vacuum resistant	
Insulation class of field coils	E	
Electrode design	pin electrodes	
Protection category (EN 60 529/IEC 529)	IP 67/NEMA 6	
Humidity rating (DIN 50 016, DIN / IEC 68)	R, relative humidity < 90% annual mean	
Grounding rings	Standard for DN 10 - 15 and 3/8" - 1/2" optional for DN 25 - 150 and 1" - 6"	
Materials		
Measuring section	virgin Teflon®-PFA	
Electrodes	Hastelloy C4	
Housing DN 10 - 40 / 3/8" - 1 1/2" DN 50 - 150 / 2" - 6"	malleable cast iron GTW S 38 steel St 37.2, paint finish	
Grounding rings	stainless steel 1.4571/SS 316 Ti-AISI (optionally for DN 25 - 150 and 1" - 6")	
Centering material	rubber sleeves	
Stud bolts (option)	steel, electrogalvanized or stainless steel 1.4301/SS 304 - AISI	
Gaskets between grounding rings and pipe flanges	not included with flowmeter, use Teflon-type gaskets to DIN 2690/ANSI B 16.21, deformable under pressure, 8-16 N/mm ² /1160 - 2320 psi	

Teflon® is a registered trademark of Du Pont

11 Dimensions and weights

PLEASE NOTE

The **total dimension for the height** is obtained from **dimension b** (see table) **plus the height** of the terminal box or the signal converter, see drawings.

The **total weight** is made up of the weight of the signal converter (see table) **plus** the weight of the terminal box or signal converter, see below.

Terminal box

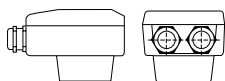

Weight approx.
0.5 kg (1.1 lb)

IFC 010 K signal converter

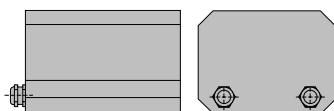

Weight approx.
1.6 kg (3.6 lb)

IFC 090 K signal converter

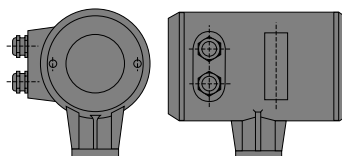

Weight approx.
2.3 kg (5.1 lb)

Meter size		Dimensions in mm (in)					Approx. weight 1)	
DN mm	(in)	a	b	1)	c	d	e	in kg (lb)
DN 10	3/8	68 (2.68)	137 (5.39)	52 (2.05)	67 (2.64)	47 (1.85)	1.7 (3.7)	
DN 15	1/2	68 (2.68)	137 (5.39)	52 (2.05)	67 (2.64)	47 (1.85)	1.7 (3.7)	
DN 25	1	54 (2.13)	147 (5.79)	52 (2.05)	62 (2.44)	66 (2.60)	1.7 (3.7)	
DN 40	1 1/2	78 (3.07)	162 (6.38)	76 (2.99)	70 (2.76)	82 (3.23)	2.6 (5.7)	
DN 50	2	100 (3.94)	151 (5.94)	98 (3.86)	50 (2.58)	101 (3.98)	4.2 (9.3)	
DN 80	3	150 (5.91)	180 (7.09)	146 (5.75)	65 (3.15)	130 (5.12)	5.7 (12.6)	
DN 100	4	200 (7.87)	207 (8.15)	196 (7.72)	78 (3.66)	156 (6.14)	10.5 (23.1)	
DN 150	6	200 (7.87)	271 (10.67)	196 (7.72)	110 (4.90)	219 (8.62)	15.0 (33.1)	

Necessary distance between flanges

DN 10 - 15 / 3/8" - 1/2" (flowmeter supplied with grounding rings)

DN 25 - 150 / 1" - 6" without grounding rings:

with grounding rings:

Dimension a + 2 × gasket thickness (2)

Dimension a only (no gaskets required)

Dimension a + 2 × gasket thickness (2)

+ 2 × 3 mm or 2 × 0.12" (thickness of grounding rings)

1) Overall height "b" and approx. weight **without** mounted terminal box or signal converter

2) Teflon-type gaskets to DIN 2690/ANSI B 16.21, deformable under pressure 8 - 16 N/mm²/1160 - 2320 psi, to be provided by customer.

DN 10 - 15 / 3/8" - 1/2"

Dimension "a" with fitted grounding rings (standard)

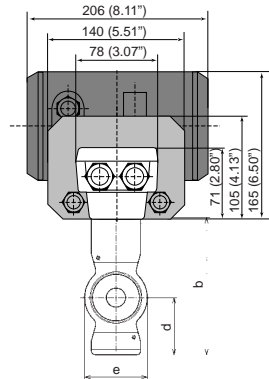
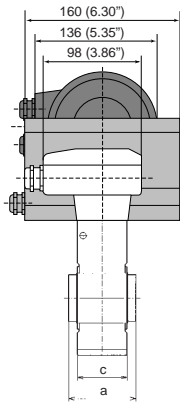

DN 25 - 40 / 1" - 1 1/2"

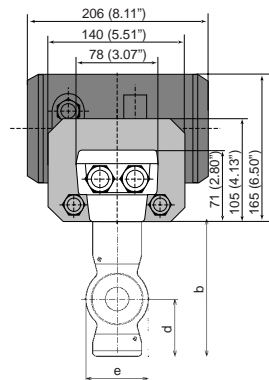
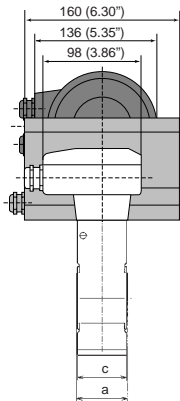

DN 50 - 150 / 2" - 6"

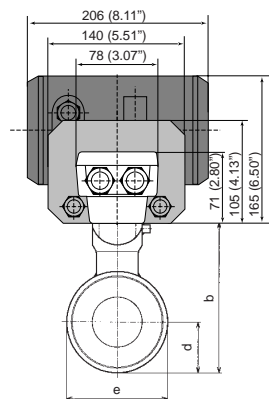
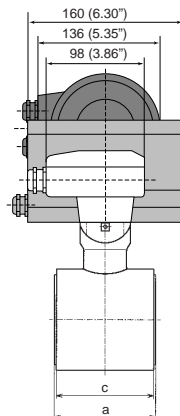

If you need to return flowmeters for testing or repair to Krohne

Your electromagnetic flowmeter

- has been carefully manufactured and tested by a company with ISO 9001 certification
- and volumetrically calibrated in one of the world's most accurate test rigs.

If installed and operated in accordance with these operating instructions, your flowmeter will rarely present any problems.

Should you nevertheless need to return a flowmeter for checkout or repair, please pay strict attention to the following points:

Due to statutory regulations concerning protection of the environment and the health and safety of our personnel, Krohne may only handle, test and repair returned flowmeters that have been in contact with liquids if it is possible to do so without risk to personnel and environment. This means that Krohne can only service your flowmeter if it is accompanied

by a certificate in line with the following model confirming that the flowmeter is safe to handle.

If the flowmeter has been operated with toxic, caustic, flammable or water-endangering liquids, you are kindly requested

- to check and ensure, if necessary by rinsing or neutralizing, that all cavities in the flowmeter are free from such dangerous substances.
(Directions on how you can find out whether the primary head has to be opened and then flushed out or neutralized are obtainable from Krohne on request.)
- to enclose a certificate with the flowmeter confirming that the flowmeter is safe to handle and stating the liquid used.

Krohne regret that they cannot service your flowmeter unless accompanied by such a certificate.

SPECIMEN certificate

Company:

Address:

Department:

Name:

Tel. No.:

The enclosed electromagnetic flowmeter

Type:

Krohne Order No. or Series No.:

has been operated with the following liquid:

Because this liquid is

water-endangering * / toxic * / caustic * / flammable *

we have

– checked that all cavities in the flowmeter are free from such substances *

– flushed out and neutralized all cavities in the flowmeter *

(* delete if not applicable)

We confirm that there is no risk to man or environment through any residual liquid contained in this flowmeter.

Date: Signature:

Company stamp: